



 **MINING**

07.2024

 **SAB**
cherish your water
 **SYSTEM GROUP**

CHERISH YOUR WATER MANIFESTO

Ci prendiamo cura dell'acqua. Con il nostro manifesto vogliamo stabilire valori, processi e soluzioni concrete per promuovere un uso efficiente e consapevole dell'acqua.

We cherish your water. With this notice we want to establish values, processes and concrete solutions to promote an educated and efficient use of water.

- 1 L'acqua è vita**
Water is life
- 2 L'acqua è una risorsa scarsa**
Water is a scarce resource
- 3 Promuoviamo l'uso consapevole dell'acqua**
We promote a conscious use of water
- 4 Cerchiamo di rendere l'acqua accessibile per abbattere le disuguaglianze**
We try to make water more accessible in order to reduce inequalities
- 5 Etica aziendale e trasparenza**
Corporate ethics and transparency
- 6 Ricerca e sviluppo di nuovi prodotti**
Research and development of new products
- 7 Scelta e lavorazione delle materie prime**
Raw materials choice and processing
- 8 Tecniche di produzione**
Production techniques
- 9 Vendite, servizi e customer care**
Sales, service and customer care
- 10 Servizi e responsabilità sociale**
Social responsibility services

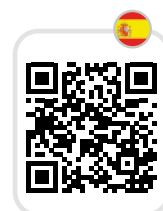
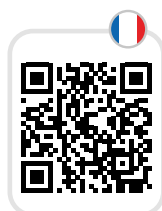

CHI SIAMO | WHO WE ARE

Lavoriamo per sviluppare prodotti performanti, affidabili e semplici da usare, che possano contribuire a rendere più semplice il lavoro degli installatori e degli agricoltori. Siamo presenti con la nostra ampia gamma in tre settori: **irrigazione, acqua & gas, drenaggio.**

We work to develop high-performance and simple-to-use products that can help make the work of installers and farmers easier. We are active in three sectors: **irrigation, water and gas, and drainage.**



INNOVAZIONE INNOVATION

68% del fatturato proviene da **prodotti lanciati o rinnovati** negli ultimi 5 anni
68% of our turnover comes from **products launched or renovated** in the last 5 years



QUALITÀ QUALITY

13 certificati internazionali e severi test di laboratorio
13 international certificates and strict laboratory tests



AFFIDABILITÀ RELIABILITY

72% del fatturato viene realizzato con **clienti fedeli da oltre 10 anni**
72% of our turnover has been achieved with **customers loyal for over 10 years**



SOSTENIBILITÀ SUSTAINABILITY

Certificazione Internazionale Ecovadis medaglia d'argento
Ecovadis international certification - silver medal

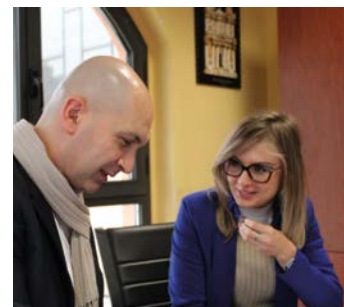



QUALITY



CERTIFICATO IT/04/1066

INDEX

	Blueseal16 Raccordi a compressione Compression fittings / Raccords à compression Accesorios compresión	06
	Plug&Play® Raccordi push-fit Push-fit fittings / Raccords push-fit / Accesorios push-fit	11
	Valvole PVC e connettori per ala gocciolante PVC valves and drip line connectors Vannes en PVC et raccords de tube gr Válvulas de PVC y conectores para ala goteadora	14

S-saddle 16



SCAN ME

RioFlex

POLYETHYLENE LAYFLAT HOSE

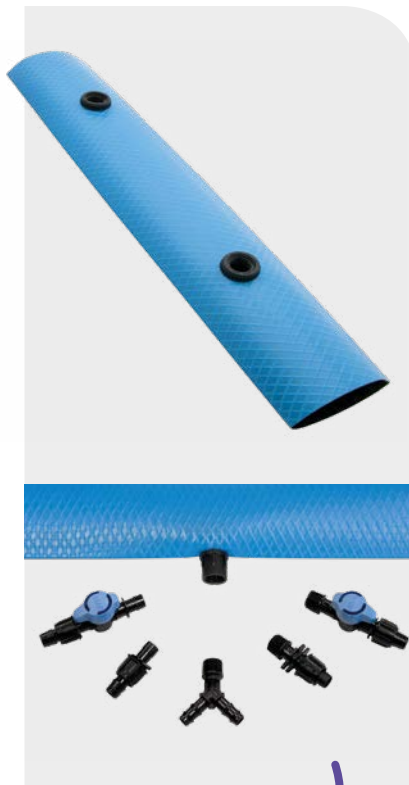

SCAN ME

Accessories

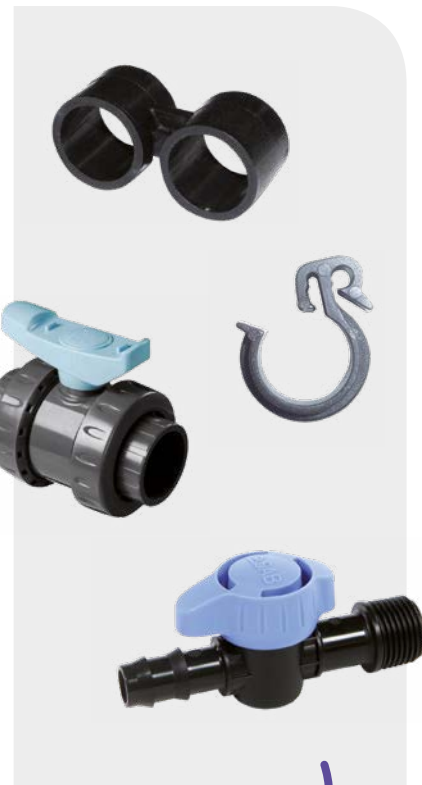

SCAN ME

Blue Seal 16

Mining

Raccordi a compressione

Compression fittings
Raccords à compression
Accesorios compresión



VANTAGGI

Facilità di inserimento del tubo
Maggiore tenuta
Rapidità di montaggio

ADVANTAGES

Easy pipe insertion
Higher water tightness
Quick assembly

AVANTAGES

Facilité d'insertion du tuyau
Super étanchéité
Rapidité de montage

VENTAJAS

Facilidad de inserción del tubo
Mayor hermeticidad
Montaje rápido



Ghiera

Nut / Ecrou / Tuerca
[PP]

Anello di aggraffaggio

Grip ring / Bague d'agrafage
Cono de fijación

[PBT]

Anello di battuta [PP]

Spacer ring / Douille de poussée
Anillo prensa O-ring

O-ring Viton

Corpo

Body / Corp / Cuerpo
[PP]

Disponibile con filetti NPT

NPT threads available
Disponibile avec filetages NPT
Disponibile con roscas NPT

Normativa

Standard / Norme / Norma

UNI EN 10226-1 (ISO 7/1)

Male threads
tapered 1:16

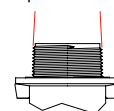

ISO 7/1 Conical

Female threads



ISO 7/1 Parallel

T a 90° ridotto

90° reducing tee
Té à 90° réduit
T a 90° reducido

PBT Grip ring
Viton O-ring



CODE: C075	PN	Ø x Ø x Ø	PACK	€
C075020016A	16	20 x 16 x 20	80 B - 20 P	10,40
C075025020A	16	25 x 20 x 25	60 B - 10 P	11,40
C075032025A	16	32 x 25 x 32	40 B - 10 P	15,60
C075040032A	16	40 x 32 x 40	21 B	26,30
C075050032A	16	50 x 32 x 50	14 B	35,50
C075050040A	16	50 x 40 x 50	14 B	35,70
C075063025A	16	63 x 25 x 63	8 B	43,70
C075063032A	16	63 x 32 x 63	8 B	45,20
C075063050A	16	63 x 50 x 63	8 B	47,00
C075075063A	16	75 x 63 x 75	4 B	75,50
C075090075A	10	90 x 75 x 90	5 A	116,00
C075110063A	10	110 x 63 x 110	4 A	203,00
C075110090A	10	110 x 90 x 110	4 A	206,00

T a 90°

90° tee
Té à 90°
T a 90°

PBT Grip ring
Viton O-ring



CODE: C080	PN	Ø x Ø x Ø	PACK	€
C080016016A	16	16 x 16 x 16	150 B - 30 P	8,50
C080020020A	16	20 x 20 x 20	80 B - 20 P	8,72
C080025025A	16	25 x 25 x 25	60 B - 10 P	11,90
C080032032A	16	32 x 32 x 32	30 B - 10 P	18,90
C080040040A	16	40 x 40 x 40	20 B	26,50
C080050050A	16	50 x 50 x 50	12 B	37,30
C080063063A	16	63 x 63 x 63	8 B	50,40
C080075075A	10	75 x 75 x 75	4 B	75,70
C080090090A	10	90 x 90 x 90	5 A	107,00
C080110110A	10	110 x 110 x 110	4 A	204,00

T a 90° filettato femmina

90° female tee
Té à 90° taraudée
T a 90° hembra

PBT Grip ring
Viton O-ring



CODE: C085	PN	Ø x D" x Ø	PACK	€
C08501600BA	16	16 x 1/2" x 16	180 B - 30 P	6,46
C08501600CA	16	16 x 3/4" x 16	180 B - 30 P	6,46
C08502000BA	16	20 x 1/2" x 20	100 B - 20 P	7,07
C08502000CA	16	20 x 3/4" x 20	100 B - 20 P	7,07
C08502500BA	16	25 x 1/2" x 25	80 B - 10 P	9,41
C08502500CA	16	25 x 3/4" x 25	80 B - 10P	9,41
C08502500DA	16	25 x 1" x 25	80 B - 10 P	10,20
C08503200CA	16	32 x 1/2" x 32	50 B - 10 P	14,10
C08503200DA	16	32 x 3/4" x 32	50 B - 10 P	14,10
C08503200BA	16	32 x 1" x 32	50 B - 10 P	14,10
C08503200EA	16	32 x 1"1/4 x 32	40 B - 10 P	16,40
C08504000DA	16	40 x 1" x 40	28 B	22,50
C08504000EA	16	40 x 1"1/4 x 40	28 B	22,50
C08504000FA	16	40 x 1"1/2 x 40	25 B	23,80
C08505000EA	16	50 x 1"1/4 x 50	18 B	31,10
C08505000FA	16	50 x 1"1/2 x 50	18 B	31,10
C08505000GA	16	50 x 2" x 50	15 B	33,70
C08506300FA	16	63 x 1"1/2 x 63	10 B	42,60
C08506300GA	16	63 x 2" x 63	10 B	42,60
C08506300IA	10	63 x 2"1/2 x 63	10 B	51,30
C08507500IA	10	75 x 2" x 75	6 B	65,90
C08507500GA	10	75 x 2"1/2 x 75	6 B	65,90
C08507500LA	10	75 x 3" x 75	4 B	65,90
C08509000IA	10	90 x 2"1/2 x 90	3 B	71,50
C08509000LA	10	90 x 3" x 90	3 B	102,00
C08511000LA	10	110 x 3" x 110	6 A	116,00
C08511000MA	10	110 x 4" x 110	6 A	159,00

Stainless steel reinforcing ring from 1"½ to 4".

T a 90° filettato maschio

90° male tee
Té à 90° fileté male
T a 90° macho

PBT Grip ring
Viton O-ring



CODE: C090	PN	Ø x D" x Ø	PACK	€
C09001600BA	16	16 x 1/2" x 16	210 B - 30 P	6,56
C09001600CA	16	16 x 3/4" x 16	180 B - 30 P	6,56
C09002000BA	16	20 x 1/2" x 20	100 B - 20 P	6,93
C09002000CA	16	20 x 3/4" x 20	100 B - 20 P	6,93
C09002500BA	16	25 x 1/2" x 25	80 B - 10 P	9,30
C09002500CA	16	25 x 3/4" x 25	80 B - 10 P	9,30
C09002500DA	16	25 x 1" x 25	70 B - 10 P	9,30
C09003200BA	16	32 x 1/2" x 32	50 B - 10 P	14,00
C09003200CA	16	32 x 3/4" x 32	50 B - 10 P	14,00
C09003200DA	16	32 x 1" x 32	50 B - 10 P	14,00
C09003200EA	16	32 x 1"1/4 x 32	40 B - 10 P	14,60
C09004000EA	16	40 x 1" x 40	28 B	20,90
C09004000FA	16	40 x 1"1/4 x 40	28 B	20,90
C09005000FA	16	40 x 1"1/2 x 40	25 B	30,30
C09005000EA	16	50 x 1"1/4 x 50	18 B	30,30
C09005000GA	16	50 x 1"1/2 x 50	18 B	31,90
C09006300FA	16	50 x 2" x 50	15 B	52,20
C09006300GA	16	63 x 1"1/2 x 63	10 B	52,20
C09006300IA	16	63 x 2" x 63	10 B	52,20
C09007500IA	16	63 x 2"1/2 x 63	10 B	73,10
C09007500LA	10	75 x 2"1/2 x 75	6 B	73,10
C09009000LA	10	75 x 3" x 75	4 B	107,00
C09001600BA	10	90 x 3" x 90	7 A	129,00
C09011000MA	10	110 x 4" x 110	5 A	179,00

T a 90° maggiorata

90° enlarging tee
Tè à 90° augmentée
Te ampliada 90°



PBT Grip ring
Viton O-ring

CODE: C076/078	PN	Ø x Ø x Ø	PACK	€
C076020025A	16	20 x 25 x 20	60 B - 10 P	11,00
C076025032A	16	25 x 32 x 25	40 B - 10 P	13,30

Raccordo femmina

Female adaptor
Raccord taraudé
Empalme hembra



PBT Grip ring
Viton O-ring

CODE: C100	PN	Ø x D"	PACK	€
C10001600BA	16	16 x 1/2"	360 B - 30 P	3,47
C10001600CA	16	16 x 3/4"	360 B - 30 P	3,47
C10002000CA	16	20 x 1/2"	280 B - 20 P	4,11
C10002000BA	16	20 x 3/4"	240 B - 20 P	4,11
C10002500BA	16	25 x 1/2"	200 B - 10 P	4,87
C10002500DA	16	25 x 3/4"	200 B - 10 P	4,87
C10002500CA	16	25 x 1"	180 B - 10 P	4,87
C10003200BA	16	32 x 1/2"	120 B - 10 P	7,16
C10003200CA	16	32 x 3/4"	120 B - 10 P	7,16
C10003200DA	16	32 x 1"	120 B - 10 P	7,16
C10003200EA	16	32 x 1 1/4"	100 B - 10 P	8,87
C10004000DA	16	40 x 1"	60 B	10,50
C10004000EA	16	40 x 1 1/4"	60 B	10,50
C10004000FA	16	40 x 1 1/2"	50 B	10,50
C10005000GA	16	50 x 1 1/4"	35 B	15,30
C10005000EA	16	50 x 1 1/2"	35 B	15,30
C10005000FA	16	50 x 2"	35 B	15,30
C10006300FA	16	63 x 1 1/2"	24 B	20,80
C10006300IA	16	63 x 2"	24 B	20,80
C10006300GA	16	63 x 2 1/2"	20 B	20,80
C10007500IA	10	75 x 2"	15 B	35,90
C10007500LA	10	75 x 2 1/2"	15 B	35,90
C10007500GA	10	75 x 3"	12 B	35,90
C10009000LA	10	90 x 2"	8 B	45,40
C10009000IA	10	90 x 2 1/2"	8 B	45,40
C10009000GA	10	90 x 3"	8 B	45,40
C10009000MA	10	90 x 4"	8 B	45,40
C10011000MA	10	110 x 2"	6 B	103,00
C10011000GA	10	110 x 3"	6 B	103,00
C10011000LA	10	110 x 4"	6 B	103,00

Stainless steel reinforcing ring from 1 1/2" to 4".

Raccordo flangiato

Flanged adaptor
Joint à bride
Enlace rebordeado



PBT Grip ring
Viton O-ring

CODE: C135	PN	Ø x D"	PACK	€
C13504000FA	16	40 x 1 1/2" (DN 40)	24 B	35,10
C13505000FA	16	50 x 1 1/2" (DN 40)	20 B	38,50
C13505000GA	16	50 x 2" (DN 50)	15 B	45,80
C13506300GA	16	63 x 2" (DN 50)	15 B	48,50
C13507500IA	16	75 x 2 1/2" (DN 65)	8 B	68,50
C13507500LA	16	75 x 3" (DN80)	8 B	75,90
C13509000LA	16	90 x 3" (DN 80)	5 B	86,00
C13509000MA	16	90 x 4" (DN100)	5 B	95,40
C13511000MA	16	110 x 4" (DN100)	3 B	113,00

Raccordo maschio

Male adaptor
Raccord fileté male
Empalme macho



PBT Grip ring
Viton O-ring

CODE: C095	PN	Ø x D"	PACK	€
C09501600BA	16	16 x 1/2"	450 B - 30 P	3,09
C09501600CA	16	16 x 3/4"	360 B - 30 P	3,09
C09502000BA	16	20 x 1/2"	280 B - 20 P	3,58
C09502000CA	16	20 x 3/4"	280 B - 20 P	3,58
C09502000DA	16	20 x 1"	280 B - 20 P	3,58
C09502500BA	16	25 x 1/2"	200 B - 10 P	4,39
C09502500CA	16	25 x 3/4"	200 B - 10 P	4,39
C09502500DA	16	25 x 1"	200 B - 10 P	4,39
C09503200BA	16	32 x 1/2"	120 B - 10 P	6,78
C09503200DA	16	32 x 3/4"	120 B - 10 P	6,78
C09503200CA	16	32 x 1"	120 B - 10 P	6,78
C09503200EA	16	32 x 1 1/4"	100 B - 10 P	7,16
C09503200FA	16	32 x 1 1/2"	100 B - 10 P	7,63
C09504000DA	16	40 x 1"	60 B	10,40
C09504000EA	16	40 x 1 1/4"	60 B	10,40
C09504000FA	16	40 x 1 1/2"	55 B	10,40
C09504000GA	16	40 x 2"	50 B	10,70
C09505000DA	16	50 x 1"	35 B	14,20
C09505000EA	16	50 x 1 1/4"	35 B	14,20
C09505000GA	16	50 x 1 1/2"	35 B	14,20
C09505000FA	16	50 x 2"	35 B	14,20
C09506300EA	16	63 x 1 1/4"	24 B	19,40
C09506300IA	16	63 x 1 1/2"	24 B	19,40
C09506300FA	16	63 x 2"	24 B	19,40
C09506300GA	16	63 x 2 1/2"	20 B	19,40
C09507500LA	16	75 x 2"	15 B	33,10
C09507500GA	16	75 x 2 1/2"	15 B	33,10
C09507500IA	16	75 x 3"	12 B	33,10
C09509000IA	16	90 x 2"	8 B	40,80
C09509000LA	16	90 x 2 1/2"	8 B	40,80
C09509000GA	16	90 x 3"	8 B	40,80
C09509000MA	16	90 x 4"	8 B	47,30
C09511000GA	16	110 x 2"	6 B	79,70
C09511000LA	16	110 x 3"	6 B	79,70
C09511000MA	16	110 x 4"	6 B	79,70

Manicotto

Coupling
Manchon
Manguito

PBT Grip ring
Viton O-ring



CODE: C105	PN	Ø	PACK	€
C105016000A	16	16	300 B - 30 P	5,02
C105020000A	16	20	160 B - 20 P	6,50
C105025000A	16	25	100 B - 10 P	8,22
C105032000A	16	32	60 B - 10 P	12,90
C105040000A	16	40	40 B	17,90
C105050000A	16	50	25 B	25,30
C105063000A	16	63	15 B	33,50
C105075000A	16	75	8 B	53,70
C105090000A	16	90	5 B	69,30
C105110000A	16	110	3 B	144,00

Manicotto ridotto

Reducing coupling
Manchon réduit
Manguito reducido

PBT Grip ring
Viton O-ring



CODE: C110	PN	Ø x Ø	PACK	€
C110020016A	16	20 x 16	180 B - 20 P	6,47
C110025016A	16	25 x 16	120 B - 10 P	7,14
C110025020A	16	25 x 20	120 B - 10 P	7,19
C110032020A	16	32 x 20	80 B - 10 P	10,40
C110032025A	16	32 x 25	80 B - 10 P	10,80
C110040025A	16	40 x 25	45 B	15,80
C110040032A	16	40 x 32	40 B	17,30
C110050025A	16	50 x 25	30 B	22,20
C110050032A	16	50 x 32	30 B	22,20
C110050040A	16	50 x 40	30 B	22,50
C110063025A	16	63 x 25	20 B	28,10
C110063032A	16	63 x 32	20 B	29,60
C110063040A	16	63 x 40	15 B	29,80
C110063050A	16	63 x 50	15 B	31,40
C110075050A	16	75 x 50	12 B	48,90
C110075063A	16	75 x 63	8 B	49,90
C110090063A	16	90 x 63	6 B	65,10
C110090075A	16	90 x 75	6 B	65,30
C110110063A	16	110 x 63	4 B	129,00
C110110075A	16	110 x 75	4 B	129,00
C110110090A	16	110 x 90	3 B	132,00

Giunto victaulic

Shouldered adaptor
Joint victaulic
Enlace victaulic

PBT Grip ring
Viton O-ring



CODE: C134	PN	Ø x D"	PACK	€
C13405000GA	16	50 x 2"	35 B	14,60
C13406300GA	16	63 x 2"	20 B	19,60
C13411000MA	16	110 x 4	6 B	93,60

Manicotto di riparazione senza battuta interna

Repair coupling without center lip
Manchon de réparation sans butée centrale /Manguito de reparación sin centro interno

PBT Grip ring
Viton O-ring



CODE: C106	PN	Ø	PACK	€
-	-	-	-	-
C106020000A	16	20	160 B - 20 P	7,54
C106025000A	16	25	100 B - 10 P	9,30
C106032000A	16	32	60 B - 10 P	14,40
C106040000A	16	40	40 B	20,10
C106050000A	16	50	25 B	28,60
C106063000A	16	63	15 B	36,80
C106075000A	16	75	8 B	60,80
C106090000A	16	90	5 B	79,80
C106110000A	16	110	3 B	160,00

Tappo

Plug
Bouchon
Tapón

PBT Grip ring
Viton O-ring



CODE: C115	PN	Ø	PACK	€
C115016000A	16	16	450 B - 30 P	3,29
C115020000A	16	20	280 B - 20 P	4,25
C115025000A	16	25	200 B - 10 P	4,91
C115032000A	16	32	120 B - 10 P	7,16
C115040000A	16	40	60 B	10,40
C115050000A	16	50	40 B	15,50
C115063000A	16	63	24 B	20,30
C115075000A	16	75	15 B	40,50
C115090000A	16	90	9 B	48,30
C115110000A	16	110	6 B	102,00

Gomito a 90°

90° elbow
Coude à 90°
Codo a 90°

PBT Grip ring
Viton O-ring



CODE: C120	PN	Ø	PACK	€
C120016000A	16	16	240 B - 30 P	5,29
C120020000A	16	20	120 B - 20 P	6,50
C120025000A	16	25	100 B - 10 P	8,31
C120032000A	16	32	60 B - 10 P	12,80
C120040000A	16	40	30 B	18,50
C120050000A	16	50	20 B	26,60
C120063000A	16	63	12 B	32,50
C120075000A	16	75	6 B	52,60
C120090000A	16	90	3 B	68,10
C120110000A	16	110	6 A	137,00

Gomito a 90° filettato femmina

90° female elbow
Coude à 90° taraudé
Codo a 90° hembra



PBT Grip ring
Viton O-ring

CODE: C125	PN	Ø x D"	PACK	€
C12501600BA	16	16 x 1/2"	300 B - 30 P	3,90
C12501600CA	16	16 x 3/4"	300 B - 30 P	3,90
C12502000BA	16	20 x 1/2"	200 B - 20 P	4,51
C12502000CA	16	20 x 3/4"	200 B - 20 P	4,51
C12502500DA	16	25 x 1/2"	150 B - 10 P	5,66
C12502500BA	16	25 x 3/4"	150 B - 10 P	5,66
C12502500CA	16	25 x 1"	130 B - 10 P	5,66
C12503200BA	16	32 x 1/2"	90 B - 10 P	8,09
C12503200CA	16	32 x 3/4"	90 B - 10 P	8,09
C12503200DA	16	32 x 1"	90 B - 10 P	8,09
C12503200EA	16	32 x 1"1/4	80 B - 10 P	10,50
C12504000FA	16	40 x 1"	45 B	14,40
C12504000EA	16	40 x 1"1/4	45 B	14,40
C12504000DA	16	40 x 1"1/2	40 B	14,40
C12505000FA	16	50 x 1"1/4	30 B	19,70
C12505000GA	16	50 x 1"1/2	30 B	19,70
C12505000EA	16	50 x 2"	25 B	19,70
C12506300IA	16	63 x 1"1/2	17 B	26,10
C12506300GA	16	63 x 2"	17 B	26,10
C12506300FA	10	63 x 2"1/2	15 B	26,10
C12507500IA	10	75 x 2"1/2	10 B	41,30
C12507500LA	10	75 x 3"	10 B	41,30
C12509000LA	10	90 x 3"	5 B	74,30
C12509000MA	10	90 x 4"	4 B	74,30
C12511000MA	10	110 x 4"	3 B	118,00

Gomito a 90° filettato maschio

90° male elbow
Coude à 90° fileté male
Codo a 90° macho



PBT Grip ring
Viton O-ring

CODE: C130	PN	Ø x D"	PACK	€
C13001600CA	16	16 x 1/2"	360 B - 30 P	3,86
C13001600BA	16	16 x 3/4"	360 B - 30 P	3,86
C13002000CA	16	20 x 1/2"	200 B - 20 P	3,94
C13002000BA	16	20 x 3/4"	200 B - 20 P	3,94
C13002500DA	16	25 x 1/2"	150 B - 10 P	5,05
C13002500BA	16	25 x 3/4"	150 B - 10 P	5,05
C13002500CA	16	25 x 1"	130 B - 10 P	5,05
C13003200BA	16	32 x 1/2"	90 B - 10 P	7,63
C13003200CA	16	32 x 3/4"	90 B - 10 P	7,63
C13003200DA	16	32 x 1"	90 B - 10 P	7,63
C13003200EA	16	32 x 1"1/4	80 B - 10 P	7,96
C13004000DA	16	40 x 1"	45 B	10,80
C13004000EA	16	40 x 1"1/4	45 B	10,80
C13004000FA	16	40 x 1"1/2	40 B	10,80
C13005000EA	16	50 x 1"1/4	30 B	15,30
C13005000FA	16	50 x 1"1/2	30 B	15,30
C13005000GA	16	50 x 2"	25 B	15,30
C13006300FA	16	63 x 1"1/2	17 B	20,50
C13006300GA	16	63 x 2"	17 B	20,50
C13006300IA	16	63 x 2"1/2	15 B	20,50
C13007500LA	16	75 x 2"1/2	10 B	37,40
C13007500IA	16	75 x 3"	10 B	37,40
C13009000LA	16	90 x 3"	5 B	48,20
C13009000MA	16	90 x 4"	5 B	48,20
C13011000MA	16	110 x 4"	3 B	92,90

Anello di aggiraffaggio

Grip ring / Bague d'agrafage
Cono de fijación

[PBT]



CODE: 77210	Ø	€
772102016	16	0,94
772102020	20	1,23
772102025	25	1,52
772102032	32	2,42
772102040	40	3,32
772102050	50	5,72
772102063	63	8,77
772102075	75	11,70
772102090	90	16,50
772102110	110	23,30

O-ring Viton



CODE: 721V	Ø	€
721016V	16	4,70
721020V	20	5,19
721025V	25	5,41
721032V	32	8,28
721040V	40	11,50
721050V	50	14,00
721063V	63	16,70
721075V	75	23,30
721090V	90	32,50
721110V	110	41,20

Smussatore tubi

Chamfering device / Dispositif de chanfreinage
Dispositivo de biselado



20...63



75...110



40...250

CODE: 9210/9212	Ø	PACK	€
9210063020A	20...63	1	44,40
9210110075A	75...110	1	80,30
9212250040A	40...250	1	635,00

Chiave per raccordi

Wrench for fittings / Clé de serrage pour les raccords
Llave para los accesorios



CODE: 9198	Ø	PACK	€
91982016040A	16...40	(AL)	40,00
91982040063A	40...63	(AL)	70,80
91982075110A	75...110	(AL)	100,00

Plug&Play®

Raccordi Push-fit

Push-fit fittings for PE pipe
Raccords d'accouplement Push-fit
Accesorios Push-fit



VANTAGGI

Semplice, veloce, affidabile
Niente saldature, né serraggi
Disponibile fino al Ø 250mm

ADVANTAGES

Simple, quick, reliable
No welding, no tightening
Now available up to Ø 250mm

AVANTAGES

Simple, rapide, fiable
Pas de soudure, pas de serrage
Disponibile jusqu'à Ø 250mm

VENTAJAS

Simple, veloz, fiable
Sin soldaduras, ni roscas
Disponibile hasta el Ø 250mm

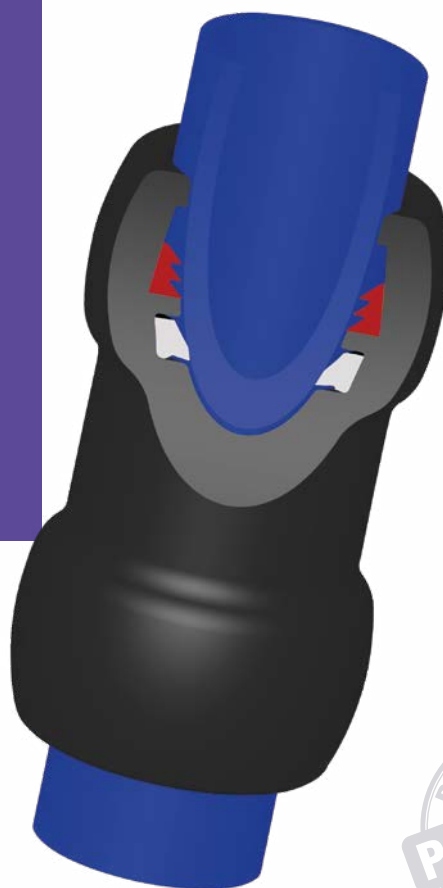

Anello di aggraffaggio

Grip ring / Bague d'agrafage
Cono de fijación
[POM]

Guarnizione

Gasket / Joint / Junta
EPDM 70sh A

Corpo

Body / Corp / Cuerpo
[PP / PE100]

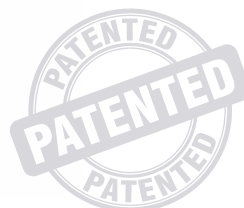

Acqua potabile

Potable water
Eau potable
Agua potable

Normative

Standards / Normes / Normas

UNI9561 / AS/NZS4129 / BRL-K 17105
DVGW GW 335-B3 / ISO17885 / UNI EN 10226-1 (ISO7/1)

Manicotto

Coupler
Manchon
Manguito

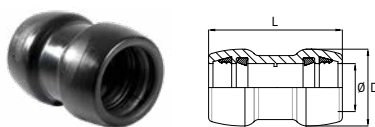

PP

CODE: PP105	PN	Ø	D	L	PACK	€
PP105020000S	16	20	37	75	150 C - 10 P	10,30
PP105025000S	16	25	44	81	100 C - 10 P	11,20
PP105032000S	16	32	53	92	60 C - 5 P	13,20
PP105040000S	16	40	66	128	36 C - 2 P	21,20
PP105050000S	16	50	78	144	20 C - 2 P	29,00
PP105063000S	16	63	97	165	12 C	38,60
PP105075000S	16	75	112	200	15 B	49,00
PP105090000S	16	90	134	219	10 B	83,20
PP105110000S	16	110	162	238	6 B	96,40
PP105125000S	16	125	179	250	5 B	117,00
PP105140000S	16	140	190	270	3 B	132,00
PP105160000S	16	160	220	303	2 B	200,00
PP105180000S	16	180	245	304	2 B	256,00
PP105200000S	10	200	266	362	1	385,00
PP105225000S	10	225	298	377	1	413,00
PP105250000S	10	250	325	441	1	523,00

Manicotto ridotto

Reducing coupling
Manchon reduit
Manguito reducido



PP

CODE: PP110	PN	Ø x Ø	D	L	PACK	€
PP110025020S	16	25x20	44	84	100 C - 10 P	11,10
PP110032025S	16	32x25	53	94	70 C - 5 P	12,50
PP110040032S	16	40x32	66	120	36 C - 2 P	18,30
PP110050040S	16	50x40	78	146	24 C - 2 P	23,80
PP110063050S	16	63x50	97	165	12 C	33,80
PE 100						
*PP111110090S	16	110x90	162	454	1	-
*PP111125110S	16	125x110	179	481	1	-
*PP111140125S	16	140x125	190	509	1	-
*PP111160125S	16	160x125	220	538	1	-
*PP111160140S	16	160x140	220	547	1	-
*PP111180160S	16	180x160	240	583	1	-
*PP111200180S	10	200x180	260	632	1	-
*PP111200160S	10	200x160	260	627	1	-
*PP111225200S	10	225x200	285	687	1	-
*PP111225180S	10	225x180	285	666	1	-
*PP111250225S	10	250x225	314	708	1	-
*PP111250200S	10	250x200	314	705	1	-

Raccordo flangiato

Flanged adaptor
Joint à bride
Enlace bridado

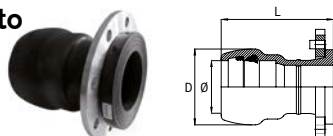

PE100

CODE: PP135	PN	Ø	DN	D	L	PACK	€
PP135090080S	16	90	80	131	205	15 A	215,00
PP135110080S	16	110	100	160	230	13 A	247,00
PP135125080S	16	125	100	178	240	13 A	275,00
PP135140080S	16	140	125	192	255	12 A	358,00
PP135160080S	16	160	150	217	275	12 A	413,00
PP135180080S	16	180	150	240	285	1	496,00
PP135200080S	10	200	200	260	350	1	688,00
PP135225080S	10	225	200	285	370	1	769,00
PP135250080S	10	250	250	314	390	1	921,00

Bicchiere

Socket
Mono joint
Enlace a soldar



PE100

CODE: PP161	PN	Ø	D	L	PACK	€
PP161090000S	16	90	132	146	15 B	65,60
PP161110000S	16	110	161	164	18 B	82,60
PP161125000S	16	125	176	176	16 B	104,00
PP161140000S	16	140	189	190	15 B	113,00
PP161160000S	16	160	232	215	14 B	138,00
PP161180000S	16	180	233	220	12 B	207,00
PP161200010S	10	200	262	237	1	327,00
PP161225010S	10	225	296	273	1	351,00
PP161250010S	10	250	319	310	1	445,00

Raccordo f/f

Female adaptor
Raccord taraudé
Empalme hembra

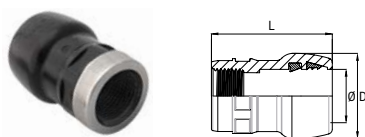

PP

CODE: PP100	PN	Ø x D"	D	L	PACK	€
PP10002000BS	16	20 x 1/2"	37	62	250 C - 10 P	7,30
PP10002000CS	16	20 x 3/4"	37	68	250 C - 10 P	7,30
PP10002500BS	16	25 x 1/2"	44	65	130 C - 10 P	8,90
PP10002500CS	16	25 x 3/4"	44	67	130 C - 10 P	8,90
PP10002500DS	16	25 x 1"	44	69	130 C - 10 P	8,90
PP10003200CS	16	32 x 3/4"	53	74	80 C - 5 P	10,70
PP10003200DS	16	32 x 1"	53	75	80 C - 5 P	10,70
PP10003200ES	16	32 x 1 1/4"	53	86	70 C - 5 P	10,70
*PP10004000DS	16	40 x 1"	66	99	40 C - 2 P	17,80
PP10004000ES	16	40 x 1 1/4"	66	100	40 C - 2 P	17,80
PP10004000FS	16	40 x 1 1/2"	66	110	40 C - 2 P	17,80
*PP10005000FS	16	50 x 1 1/2"	78	112	24 C - 2 P	24,20
PP10005000GS	16	50 x 2"	78	120	24 C - 2 P	24,20
*PP10006300FS	16	63 x 1 1/2"	97	128	18 C	32,00
PP10006300GS	16	63 x 2"	97	125	18 C	32,00

Raccordo f/m

Male adaptor
Raccord fileté
Empalme macho

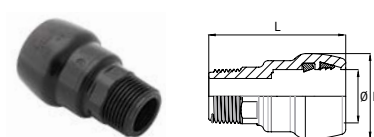

PP

CODE: PP095	PN	Ø x D"	D	L	PACK	€
PP09502000BS	16	20 x 1/2"	37	67	250 C - 10 P	6,55
PP09502000CS	16	20 x 3/4"	37	66	250 C - 10 P	6,60
PP09502500BS	16	25 x 1/2"	44	73	130 C - 10 P	7,00
PP09502500CS	16	25 x 3/4"	44	72	130 C - 10 P	7,13
PP09502500DS	16	25 x 1"	44	74	130 C - 10 P	7,22
PP09503200CS	16	32 x 3/4"	53	80	80 C - 5 P	7,87
PP09503200DS	16	32 x 1"	53	85	80 C - 5 P	7,87
*PP09503200ES	16	32 x 1 1/4"	53	87	70 C - 5 P	7,87
PP09504000DS	16	40 x 1"	66	105	40 C - 2 P	13,10
PP09504000ES	16	40 x 1 1/4"	66	109	40 C - 2 P	13,10
*PP09504000FS	16	40 x 1 1/2"	66	109	40 C - 2 P	13,10
PP09505000FS	16	50 x 1 1/2"	78	121	24 C - 2 P	17,30
*PP09505000GS	16	50 x 2"	78	122	24 C - 2 P	17,30
PP09506300FS	16	63 x 1 1/2"	97	133	18 C	24,50
PP09506300GS	16	63 x 2"	97	139	18 C	24,50

*disponibile su richiesta / available upon request.

T a 90°

90° tee
Tè à 90°
T a 90°

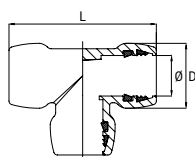

PP

CODE: PP080	PN	Ø	D	L	PACK	€
PP080020020S	16	20	37	92	90 C - 10 P	14,30
PP080025025S	16	25	44	106	50 C - 10 P	15,10
PP080032032S	16	32	53	120	30 C - 5 P	19,60
PP080040040S	16	40	66	165	14 C - 2 P	30,70
PP080050050S	16	50	79	190	8 C - 2 P	42,00
PP080063063S	16	63	99	220	5 C	59,80

PE 100

*PP081090000S	16	90	134	562	1	-
*PP081110000S	16	110	162	614	1	-
*PP081125000S	16	125	179	659	1	-
*PP081140000S	16	140	190	706	1	-
*PP081160000S	16	160	220	775	1	-
*PP081180000S	16	180	240	825	1	-
*PP081200010S	10	200	260	913	1	-
*PP081225010S	10	225	285	978	1	-
*PP081250010S	10	250	314	1032	1	-

T a 90° f/f

Female tee
Tè à 90° taraudée
T a 90° hembra

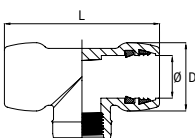

PP

CODE: PP085	PN	Ø x D"	D	L	PACK	€
PP08502000BS	16	20 x 1/2"	37	92	100 C - 10 P	11,30
*PP08502000CS	16	20 x 3/4"	37	92	100 C - 10 P	11,30
*PP08502500BS	16	25 x 1/2"	44	106	50 C - 10 P	12,50
PP08502500CS	16	25 x 3/4"	44	106	50 C - 10 P	12,50
*PP08502500DS	16	25 x 1"	44	106	40 C - 10 P	12,50
*PP08503200CS	16	32 x 3/4"	53	120	30 C - 5 P	16,20
PP08503200DS	16	32 x 1"	53	120	30 C - 5 P	16,20
*PP08504000DS	16	40 x 1"	66	165	20 C - 2 P	24,70
PP08504000ES	16	40 x 1 1/4"	66	165	20 C - 2 P	24,70
PP08505000FS	16	50 x 1 1/2"	79	190	12 C - 2 P	33,80
*PP08506300FS	16	63 x 1 1/2"	97	220	8 C	33,80
PP08506300GS	16	63 x 2"	97	220	8 C	48,00

Gomito a 90° f/f

90° female elbow
Coude à 90° taraudée
Codo a 90° hembra

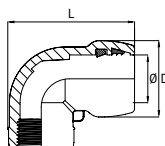

PP

CODE: PP125	PN	Ø x D"	D	L	PACK	€
PP12502000BS	16	20 x 1/2"	37	65	160 C - 10 P	7,30
*PP12502000CS	16	20 x 3/4"	37	69	140 C - 10 P	7,30
*PP12502500BS	16	25 x 1/2"	44	73	100 C - 10 P	9,14
PP12502500CS	16	25 x 3/4"	44	75	100 C - 10 P	9,14
*PP12502500DS	16	25 x 1"	44	79	80 C - 10 P	9,14
*PP12503200CS	16	32 x 3/4"	53	87	60 C - 5 P	10,70
PP12503200DS	16	32 x 1"	53	88	60 C - 5 P	10,70
*PP12504000DS	16	40 x 1"	66	113	26 C - 2 P	17,80
PP12504000ES	16	40 x 1 1/4"	66	113	26 C - 2 P	17,80
PP12505000FS	16	50 x 1 1/2"	78	131	18 C - 2 P	24,00
*PP12506300FS	16	63 x 1 1/2"	97	156	12 C	32,00
PP12506300GS	16	63 x 2"	97	156	12 C	32,00

*disponibile su richiesta / available upon request.

T a 90° ridotto

Reduced tee
Tè à 90° réduit
T a 90° reducido

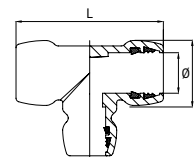

PP

CODE: PP075	PN	Ø x Ø	D	L	PACK	€
PP075025020S	16	25 x 20	44	106	50 C - 10 P	15,10
PP075032025S	16	32 x 25	53	120	30 C - 5 P	19,60
PP075040032S	16	40 x 32	66	165	14 C - 2 P	30,70
PP075050040S	16	50 x 40	79	190	8 C - 2 P	41,90
PP075063050S	16	63 x 50	99	220	5 C	59,80

PE 100

*PP076110090S	16	110 x 90	110	162	1	-
*PP076125090S	16	125 x 90	125	179	1	-
*PP076140090S	16	140 x 90	140	190	1	-
*PP076160125S	16	160 x 125	160	220	1	-
*PP076180125S	16	180 x 125	180	240	1	-
*PP076200160S	10	200 x 160	200	260	1	-
*PP076225160S	10	225 x 160	225	285	1	-
*PP076250160S	10	250 x 160	250	314	1	-

T a 90° f/m

Male tee
Tè à 90° fileté
T a 90° macho

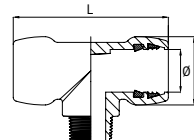

PP

CODE: PP090	PN	Ø x D"	D	L	PACK	€
PP09002000BS	16	20 x 1/2"	37	92	100 C - 10 P	10,70
PP09002500CS	16	25 x 3/4"	44	106	50 C - 10 P	11,80
PP09003200DS	16	32 x 1"	53	120	30 C - 5 P	16,20
PP09004000ES	16	40 x 1 1/4"	66	165	20 C - 2 P	24,70
PP09005000FS	16	50 x 1 1/2"	79	190	12 C - 2 P	33,80
PP09006300GS	16	63 x 2"	97	220	8 C	48,00

Gomito a 90° f/m

90° male elbow
Coude à 90° fileté
Codo a 90° macho

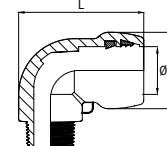

PP

CODE: PP130	PN	Ø x D"	D	L	PACK	€
PP13002000BS	16	20 x 1/2"	37	64	160 C - 10 P	6,84
PP13002500CS	16	25 x 3/4"	44	73	100 C - 10 P	7,62
PP13003200DS	16	32 x 1"	53	87	60 C - 5 P	9,14
PP13004000ES	16	40 x 1 1/4"	66	113	26 C - 2 P	13,90
PP13005000FS	16	50 x 1 1/2"	78	131	18 C - 2 P	18,90
PP13006300GS	16	63 x 2"	97	156	12 C	26,70

Gomito a 90°

90° elbow
Coude à 90°
Codo a 90°

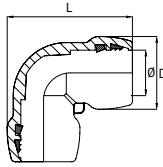

PP

CODE: PP120	PN	Ø	D	L	PACK	€
PP120020000S	16	20	37	68	140 C - 10 P	10,60
PP120025000S	16	25	44	78	90 C - 10 P	11,70
PP120032000S	16	32	53	91	50 C - 5 P	13,10
PP120040000S	16	40	66	119	20 C - 2 P	24,70
PP120050000S	16	50	78	137	12 C - 2 P	34,30
PP120063000S	16	63	97	165	9 C	41,40

PE 100

*PP121090000S	16	90	134	349	1	-
*PP121110000S	16	110	162	389	1	-
*PP121125000S	16	125	179	419	1	-
*PP121140000S	16	140	190	448	1	-
*PP121160000S	16	160	220	497	1	-
*PP121180000S	16	180	240	533	1	-
*PP121200010S	10	200	260	586	1	-
*PP121225010S	10	225	285	629	1	-
*PP121250010S	10	250	314	669	1	-

Tappo

End plug
Bouchon
Tapón

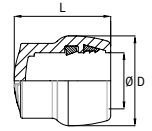

PP

CODE: PP115	PN	Ø	D	L	PACK	€
PP115020000S	16	20	37	45	300 C - 10 P	6,18
PP115025000S	16	25	44	50	200 C - 10 P	6,97
PP115032000S	16	32	53	57	100 C - 5 P	7,91
PP115040000S	16	40	66	76	60 C - 2 P	13,00
PP115050000S	16	50	78	86	36 C	19,10
PP115063000S	16	63	97	98	20 C	26,20

PE 100

*PP116090000S	16	90	134	233	1	-
*PP116110000S	16	110	162	236	1	-
*PP116125000S	16	125	179	261	1	-
*PP116140000S	16	140	190	266	1	-
*PP116160000S	16	160	220	288	1	-
*PP116180000S	16	180	240	313	1	-
*PP116200010S	10	200	260	348	1	-
*PP116225010S	10	225	285	363	1	-
*PP116250010S	10	250	314	379	1	-

Inseritore

Inserting device
Emboîteur
Insertor



CODE: 8870	Ø min	Ø max	PACK	€
8870090160	90	180	1	2.141,00
8870160250	160	250	1	3.611,00

Installazione

Installation / Installation
Instalación

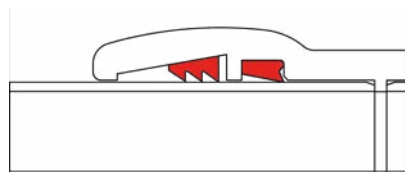

Posizione di riposo

Rest position
Position de repos
Posición de Reposo

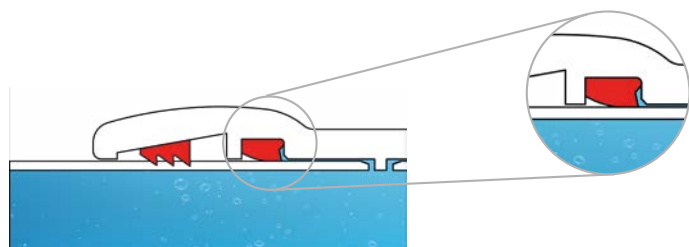

Pinza Plug&Play attivata

The grip ring is activated
Pinza Plug&Play attivata
The grip ring is activated



Valvole PVC e connettori per ala gocciolante

PVC valves and drip line connectors
Vannes en PVC et raccords de tube gr
Válvulas de PVC y conectores para ala goteadora

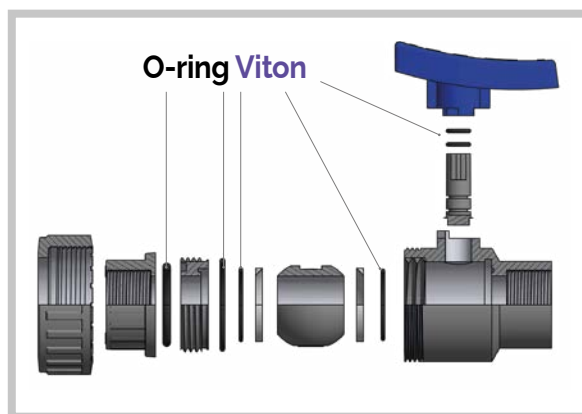

Valvola a sfera PVC bighiera f/f

True union PVC ball valve female threaded
Vanne a bille à double union PVC taraudée
Válvula esfera PVC doble tuerca rosca hembra



16 bar O-ring Viton

CODE: 9005V	D"	PACK	€
900500000BV	1/2"	60 G	44,10
900500000CV	3/4"	36 G	47,70
900500000DV	1"	50 G	67,90
900500000EV	1" 1/4	30 G	84,90
900500000FV	1" 1/2	20 G	102,00
900500000GV	2"	12 G	158,00
900500000IV	2" 1/2	5 G	478,00
900500000LV	3"	3 G	648,00
900500000MV	4"	2 G	830,00

Valvola a sfera PVC monoghiera f/f

Single union PVC ball valve female threaded
Vanne a bille à simple union PVC taraudée
Válvula esfera mono tuerca PVC rosca hembra



16 bar O-ring Viton

CODE: 9007V	D"	PACK	€
900700000BV	1/2"	60 G	35,70
900700000CV	3/4"	90 G	39,90
900700000DV	1"	60 G	45,30
900700000EV	1" 1/4	35 G	61,50
900700000FV	1" 1/2	25 G	79,90
900700000GV	2"	12 G	135,00
900700000IV	2" 1/2	5 G	237,00
900700000LV	3"	3 G	366,00
900700000MV	4"	2 G	648,00

Valvolina portagomma

Barbed valve
Vanne porte-caoutchouc
Válvulita porta goma



4 bar

CODE: 02210	Ø x Ø	PACK	€
02210016000	16 x 16	500 B - 50 P	1,24
02210020000	20 x 20	500 B - 50 P	1,26

Valvolina portagomma - f/m

Barbed - male threaded valve
Vanne porte-caoutchouc - fileté male
Válvulita porta goma - rosca macho



4 bar

CODE: 02220	Ø x D"	PACK	€
0222001600B	16 x 1/2"	500 B - 50 P	1,28
0222001600C	16 x 3/4"	450 B - 50 P	1,33
0222002000B	20 x 1/2"	500 B - 50 P	1,32
0222002000C	20 x 3/4"	400 B - 50 P	1,42

Valvolina portagomma - innesto con gommino tubo PE

Barbed - off-take with gasket for PE pipe valve
Vanne porte-caoutchouc - tuyau PE avec joint
Válvulita porta goma - injerto con goma para tubo PE



4 bar

CODE: 02235	Ø	⊕	PACK	€
02235016000	16	12	500 B - 50 P	1,38
02235020000	20	12	500 B - 50 P	1,39

Staffetta portagomma con gommino

Barbed connector with gasket
Connecteur porte-caoutchouc avec capsule en caoutchouc
Abrazadera porta goma con goma



CODE: 2046	Ø	⊕	PACK	€
2046016	16	12	2800 B - 200 P	0,26
2046020	20	12	1000 B - 100 P	0,29

Ypsilon f/m

Male threaded Ypsilon
Raccord Y fileté male
Ypsilon rosca macho



C

CODE: 02036	Ø	PACK	€	
0203601600B	C	1/2" x 16	700B - 10P	2,33
0203601600C	C	3/4" x 16	600B - 10P	2,33

Ypsilon portagomma

Barbed Ypsilon
Raccord Y porte-caoutchouc
Ypsilon porta goma



A

CODE: 0203	Ø	PACK	€	
02035016016	A	16	700B - 10P	2,33

Manicotto portagomma

Barbed coupling
Machon porte-caoutchouc
Manguito porta goma



CODE: 9190	Ø	PACK	€
9190016000	16	2500 B - 500 P	0,22
9190020000	20	1250 B - 250 P	0,29
9190020016	20 x 16	1500 G - 250 P	0,29
9190025016	25 x 16	700 G - 100 P	0,76
9190025020	25 x 20	700 G - 100 P	0,78

TE 90° portagomma

90° barbed tee
Te a 90° porte-caoutchouc
T a 90° porta goma



CODE: 9191	Ø x Ø x Ø	PACK	€
9191016000	16 x 16 x 16	1000 G - 250 P	0,32
9191020000	20 x 20 x 20	400 G - 50 P	0,73

Tappo portagomma

Barbed end plug
Bouchon porte-caoutchouc
Tapón porta goma



CODE: 2060	Ø	Ø	PACK	€
2060016	16	12	3000 G - 500 P	0,15
2060020	20		2000 G - 200 P	0,35

Raccordo portagomma - innesto tubo PVC

Barbed - off-take for PVC pipe adaptor
Raccord porte-caoutchouc - tuyau PVC
Enlace porta goma - injerto para tubo PVC



CODE: 02049	Ø	Ø	PACK	€
720490016	16	16	2400 B - 100 P	0,22
72050016B	16	16	2400 B - 100 P	0,28

Canotto f/m portagomma

Barbed male adaptor
Machon porte-caoutchouc fileté male
Empalme macho/porta goma



CODE: 9195	Ø x D"	PACK	€
919501600B	16 x 1/2"	1200 B - 100 P	0,52
919501600C	16 x 3/4"	700 B - 100 P	0,60
919502000B	20 x 1/2"	1000 B - 100 P	0,63
919502000C	20 x 3/4"	700 B - 100 P	0,63

TE 90° f/m portagomma

90° male threaded barbed tee
Tee a 90° porte-caoutchouc avec dérivation fileté
T a 90° tuerca macho porta goma



CODE: 9192	Ø x D" x Ø	PACK	€
919201600B	16 x 1/2 x 16	600 G - 100 P	0,75
919201600C	16 x 3/4 x 16	400 G - 100 P	0,75
919202000B	20 x 1/2 x 20	450 G - 50 P	1,03
919202000C	20 x 3/4 x 20	350 G - 50 P	1,03

Gomito f/m portagomma

Male threaded/barbed elbow
Coude fileté male/porte-caoutchouc
Codo tuerca macho porta goma



CODE: 9194	Ø x D"	PACK	€
919401600B	16 x 1/2"	1000 G - 100 P	0,70
919401600C	16 x 3/4"	700 G - 100 P	0,73
919402000B	20 x 1/2"	700 G - 100 P	0,77
919402000C	20 x 3/4"	600 G - 100 P	0,84

Gomito 90° porta goma

90° barbed elbow
Coude à 90° porte-caoutchouc
Codo a 90° porta goma



CODE: 9193	Ø	PACK	€
9193016000	16	1200 G - 100 P	0,50
9193020000	20	700 G - 100 P	0,65

Per altri diametri

For other diameters:
Pour d'autres diamètres
Para otros diámetros





Condizioni generali di vendita
Sale conditions
Conditions générales de vente
Condiciones generales de venta
www.sabspa.com

Elenco prodotti a marchio
Certified products schedule
Liste de produits homologués
Lista de productos homologados
www.iip.it
www.kiwa.com/nl

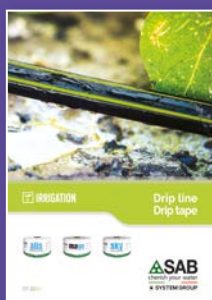

SAB S.p.A.
via Salvo D'Acquisto
61048 Sant'Angelo in Vado (PU)
ITALY
tel. +39 0722 810 800
fax +39 0722 810 158
sab@tubi.net
www.sabspa.com

Società soggetta a direzione e coordinamento
da parte di HB Boscarini S.p.A.



**BILANCIO DI
SOSTENIBILITÀ
SUSTAINABILITY
REPORT**

